



User Manual

NanoGenizer-Dual Series
High Pressure Homogenizers
(Laboratory Dual-pump Electric Bench-Top)



1. Open-box Inspection.....	3
2. Product Overview	3
2.1 Brief Introduction	3
2.2 Specification	4
2.3 Standard Features	4
2.4 Options.....	5
3. Safety Instructions.....	6
4. Preparation	9
5. Installation	10
5.1 Placement of the Homogenizer.....	10
5.2 Assembly of the Homogenizer	10
5.3 Disassembly of the Plunger Seal	12
5.4 Assembly of the Plunger Seal.....	14
6. Operation	15
6.1 Operation Method.....	15
6.2 Operation Instruction	17
6.3 User Operation Interface	18
6.4 Selection Interface for the Customer Setup & Factory Setup.....	19
6.5 Customer Setup	20
6.6 Factory Setup	21
6.7 Varieties of Inlet and Outlet for NanoGenizer	21
7. Trouble Shootings.....	22
7.1 Mechanical Trouble Shootings.....	22
7.2 Trouble Shootings of Electric Appliance	23
8. Maintenance	24
8.1 Cleaning.....	24
8.2 High Pressure Weep Holes	24
Appendix: Components List	26

1. Open-box Inspection

Check whether there is any packing damage. Refer to the *Packing Slip* for the integrity of the product.

2. Product Introduction

2.1 Brief Introduction

NanoGenizer-Dual series is a dual-pump bench-top electric micro-jet homogenizer which operated on the touch screen and controlled intelligently by program. The two pumps can be used separately, in parallel or in series. With compact design, it's especially suitable for laboratory preparation of fat emulsion, liposome, nano-suspension, micro-emulsion, lipid microsphere, nano-emulsions, dairy products, infusion solutions, cell disruption, juice homogeneity, fine chemical engineering, dye and etc. The maximum working pressure is 30000 Psi/2000 Bar. All parts touching with medium are 316L stainless steel, 17-4ph stainless steel, titanium alloy, tungsten carbide, PTFE, UHMWPE or other corrosion resistance materials.



2.2 Specification

Catalog No.	NanoGenizer-Dual
Max. Flow rate	180mL/min at 25,000psi, 120mL/min at 30,000psi
Min. Sample	30mL
Max. Pressure	30,000psi
Dimensions (cm)	72×43×33
Weight	60 kg
Max. Temp.	80°C (176°F)
Power	220V
Cleaning	Flush to clean
Application	Nano emulsion, fat emulsion, liposome, cell disruption, nano dispersion, deagglomeration
Feature	Notable shear rate; Powerful microjet; Greater repeatability; Guaranteed scalability;

2.3 Standard Features

Parts	Y-type Diamond interaction chamber with cooling option
Control System	High pressure programming control systems [®] : Touch Screen, Speed control, Auto stop control by time, pressure or temperature, display of flow rate and time, overload protection
Pressure Gauge	Digital display on the touch screen
Inlet type	1/4" HP coupling
Outlet type	1/4" HP coupling
Feed Reservoir	300mL S/S Cylinder
Collector Reservoir	S/S Pipe
Product material	316L Stainless Steel, Tungsten Carbide, Viton, Teflon
Material standard	Pharmaceutical Grade, FDA, GMP
Warranty	1 year against any manufacturing defects

2.4 Options

Parts	High pressure extruders, Homogenizing valves two stages, Heat exchanger
Control System	Speed; Start; Stop Control
Detector	Pressure gauge, Pressure transducer up to 8 optional, Temperature transducer up to 8 optional
Outlet type	Tri-Clamp or Luer
Feed Reservoir	10mL, 20mL, 50mL, 100mL, 200mL Syringe, Tank or Online
Collector Reservoir	10mL, 20mL, 50mL, 100mL, 200mL Syringe, Tank or Online
Cylinder	Titanium High pressure Cylinder (Resistant to strong acid and base)

3. Safety Instructions

Operating the NanoGenizer-Dual homogenizer involves the handling of the samples at ultra high pressure. Therefore, the operation instructions must be well noted to avoid any personal injury by ignoring the instructions or equipment damage by improper operations. DO NOT proceed until the operator fully read and understand the instructions listed in this chapter. Also, the personal shield is recommended during the operation, and the high pressure homogenizer and extruder are recommended to be operated in the shielded hood or space.

Instructions of "ATTENTION", "WARNING", "DANGER":



ATTENTION: INDICATE THE CORRECT PROCEDURES AND PRACTICES FOR OPERATION AND MAINTENANCE, TO AVOID DAMAGE TO THE EQUIPMENT OR OTHER PROPERTIES.











WARNING: INDICATE POTENTIAL DANGERS. CORRECT PROCEDURES AND PRACTICES NEED TO BE FOLLOWED TO AVOID PERSONAL INJURY.





DANGER: INDICATE THE IMPROPER HANDLING, WHICH COULD CAUSE HAZARDOUS CONDITION, BODILY INJURY OR EQUIPMENT DAMAGE.

Safety Instructions

-  **Warning:** The equipment or the components cannot be changed without authorization.
-  **Warning:** It's necessary to completely read the user manual before operating the NanoGenizer-Dual homogenizer. The operator should be familiar with all the functions and controls of this system.
-  **Warning:** Please wear the proper individual protective gear when operating the NanoGenizer-Dual homogenizer.
-  **Warning:** Do not exceed the rated range. The NanoGenizer-Dual homogenizer has designed maximum working pressure. Once exceeding, it would cause the equipment damage or bodily injury.
-  **Warning:** Do not screw up the firmware or move the equipment when the equipment is running or is under pressure.
-  **Warning:** Do not use the broken components and always replace them in time.
-  **Warning:** The working pressure of this system should not exceed the maximum pressure of the rated component of this system. A pressure gauge can be installed in the system for checking the pressure condition of the system anytime.
-  **Warning:** DO NOT point the inlet and outlet of high pressure devices and equipments supplied by the Genizer, including high pressure coupling units, interaction chambers, HP valves and other high pressure fittings, to any personnel and object which may induce the safety issue and property loss. The user and buyer should completely responsible for the violation of the clause and recommendation besides any other unsafe practices.
-  **Warning:** Handle the equipment gently and do not put heavy things on the equipment.

Safety Instructions

 **Attention:** Keep the NanoGenizer-Dual homogenizer far away from the open fire and high temperature. The overheated environment would damage the sealing element, hosepipe and parts of the electric appliance components. The performance of the homogenizer will be affected if the ambient temperature is higher than 60°C.

 **Danger:** The parts cannot be fixed only by the force of close-fitting. It could cause personal injuries if popping when the system pressure is too high.

 **Warning:** NanoGenizer-Dual homogenizer should be maintained by qualified technician. The user should be responsible for any improper maintenance.

 **Warning:** Using original parts to replace worn or damaged parts. Replacement with non-original parts will not be warranted.

4. Preparation

- Make sure all connectors and hoses, electric wiring are in correct position. The rated pressure class of connectors and hoses should be followed, and the power-supply wiring should use the rated voltage and current.
- The tightness degree of all thread fittings should be in moderate, not too loose or too tight.
- Make sure all pipe fittings are connected properly to the outlet and inlet, which should not exceed the load of NanoGenzier-Dual homogenizer.
- The medium must be compatible with 316L stainless steel. Please consult with the manufacturer for details if you are not sure about the medium property. The following is the medium that can be used:

- Distilled Water
 - Petroleum
 - Diester
 - Silicone Oil
 - Surfactants
 - Strong Acids and Base
 - Soluble oil (water-in-oil emulsion)
 - Alcohol
 - Acetone
 - Lipids
 - Other organic solvent
- ⚠ **Titanium cylinder needed**



Warning: The large area of corrosion damage of NanoGenzier-Dual homogenizer caused by improper use of medium is not covered in the warranty.

5. Installation

NanoGenizer-Dual series electric ultrahigh pressure homogenizer is an ultrahigh pressure homogenizer equipment operated on the touch screen and controlled intelligently by PLC. The power supply for the whole set of the equipment is 220V. The homogenizer should be installed according to the part drawing in the *Components List*.



Warning: Fail to follow the chapter 5 might lead to personal injuries or damage to the equipment.

5.1 Placement of the Homogenizer

The equipment is heavy and should be placed on a stable platform. The equipment has non-slip foot-pads which do not need other fixing methods. The equipment requires extra space for safety and convenient operation.

5.2 Assembly of the Homogenizer

Most of the components of this equipment have been assembled before leaving factory. Some peripherals with different joint pipes according to the special requirements of users should be assembled by the operator. For details, please refer to the component detailed parts drawing of *Components List* for assembling.



Figure 1

- 1) Please refer the assembled drawing to Figure 1.
- 2) Remain two-three circles of threads when screw the collar into the tubing as indicated in the Figure 2.

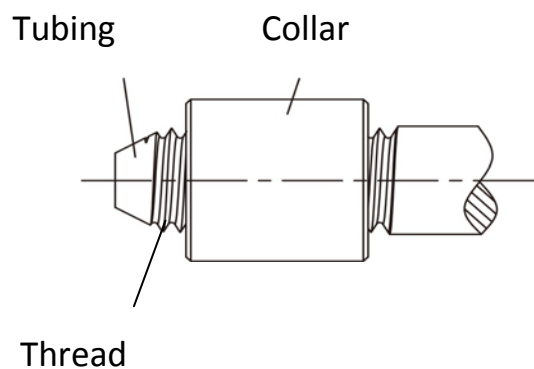

Figure 2

- 3) When installing the high pressure outlet connection, please pay attention to the installation direction of this high pressure connection.

5.3 Disassembly of the Plunger Seal

Regular replacement of the plunger seals is necessary when the seal parts is worn out. Use the supplied S/S disassemble tool to separate the high pressure cylinder of the homogenizer as indicated in Figure 3.

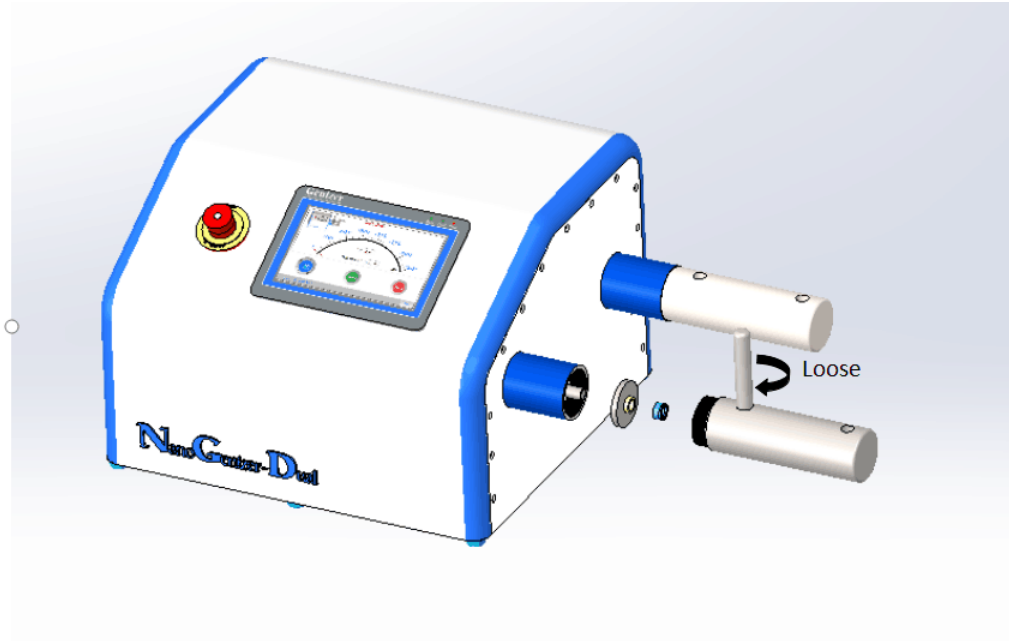

Figure 3



Warning: Before any disassemble or assemble procedure, please TURN OFF the NanoGenizer-Dual first, then remove all the high pressure components from the S/S cylinder, including the DIXCs, heat exchanger, priming valve, fittings, inlet reservoir and other connections.

Installation

Below shows the plunger seal disassemble steps:

- First, screw the plugs① into the open ends of high pressure cylinder.
- Then, stand the cylinder upright to fill the center with some water②.
- After that, insert the supplied disassemble rod③ into the center cavity.
- Push the rod way down④ with bare hands until the S/S gasket and seal unit pop out and separate from the cylinder.

Inspect the plunger seal, and replace a new set if there is any sign of wear on it.

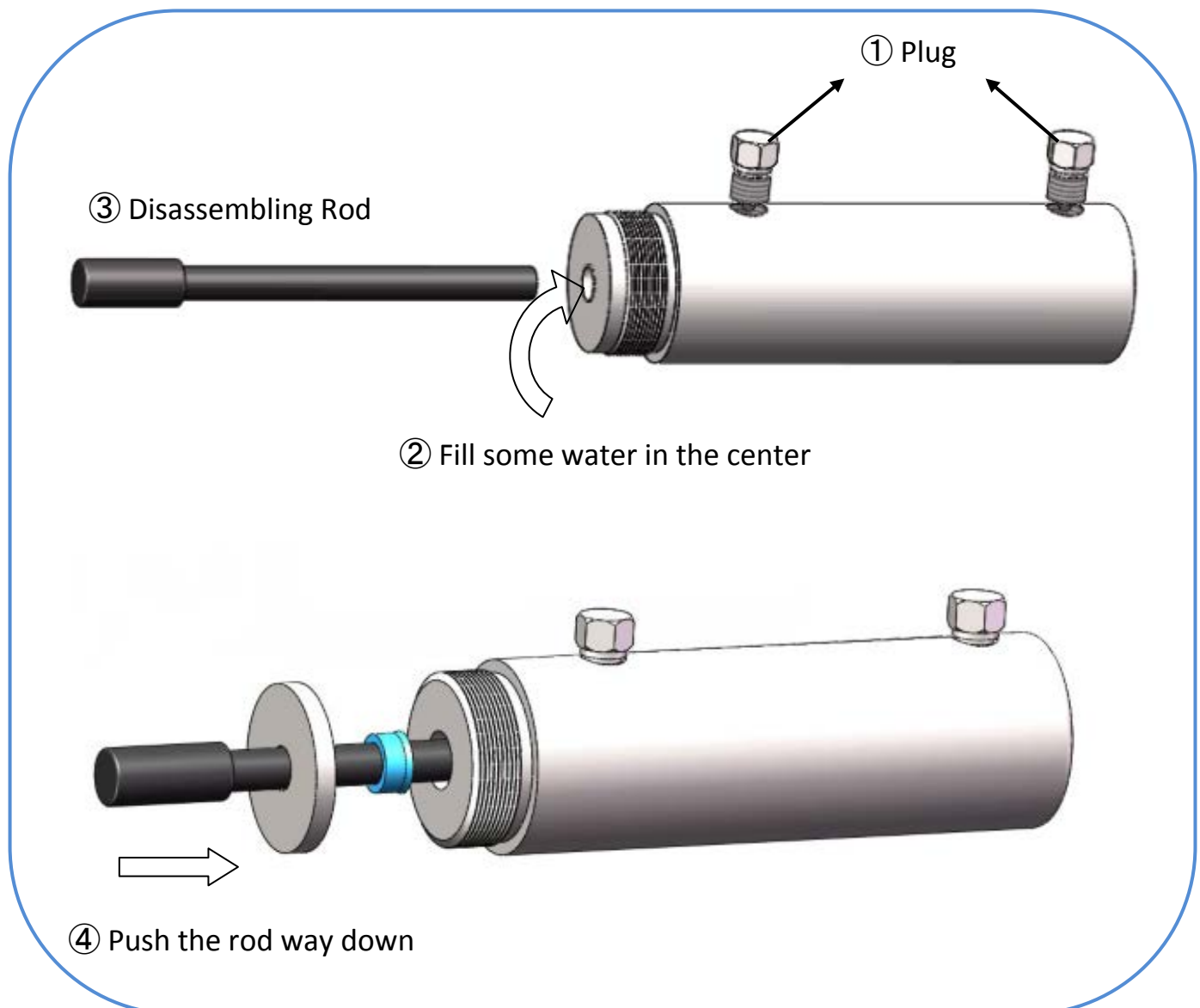

Figure 4

5.4 Assembly of the Plunger Seal

As shown in the Figure 5, for assembling the plunger seal, first screw tight the supplied assemble tool^⑤ onto the cylinder. Then, insert the replaced UHMW-PE plunger seal^⑥ into the center of the assemble tool (**NOTE: the small O-ring should face up**). Last, lightly push the supplied assemble rod^⑦ with the palm until the seal unit is inside the pump body. Remove all the tools to finish the assemble procedure of the plunger seal

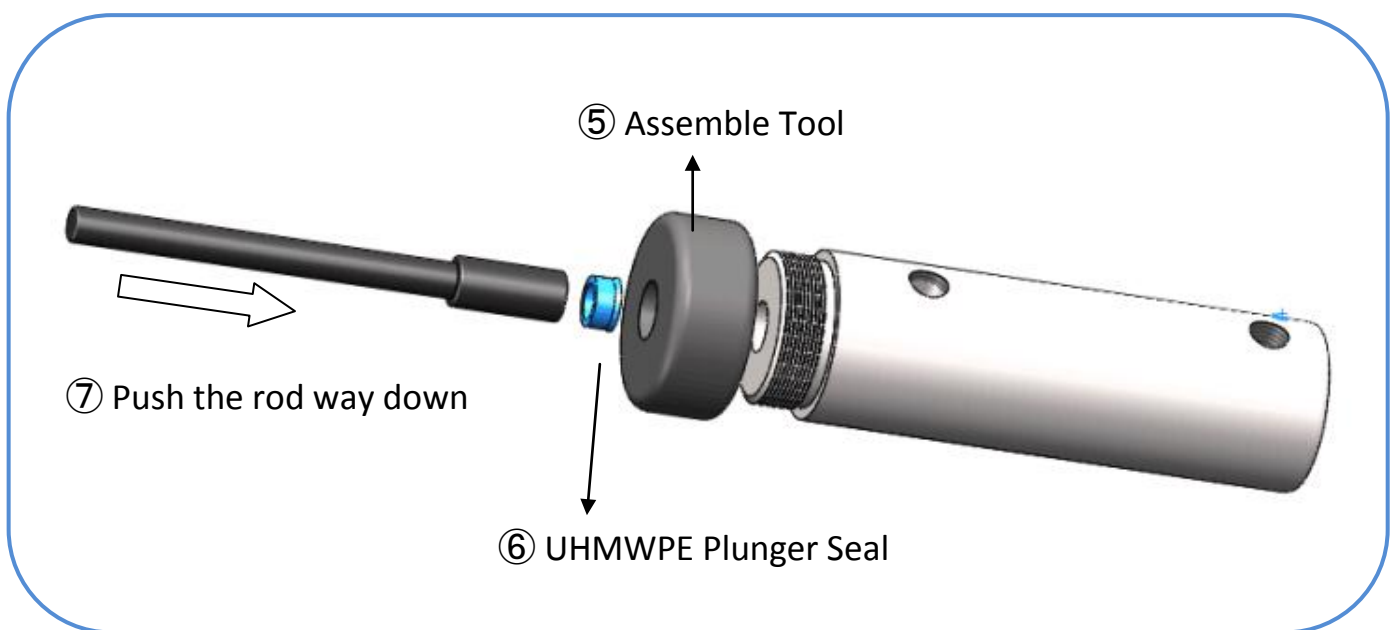

Figure 5

6. Operation

6.1 Operation Method

1) Two Pumps Used Separately:

The pump 1 pushes the sample from inlet 1 to outlet 1 first and then the pump 2 pushes the sample from inlet 2 to outlet 2. (Two different outlets ; different samples with the same homogenizer.)

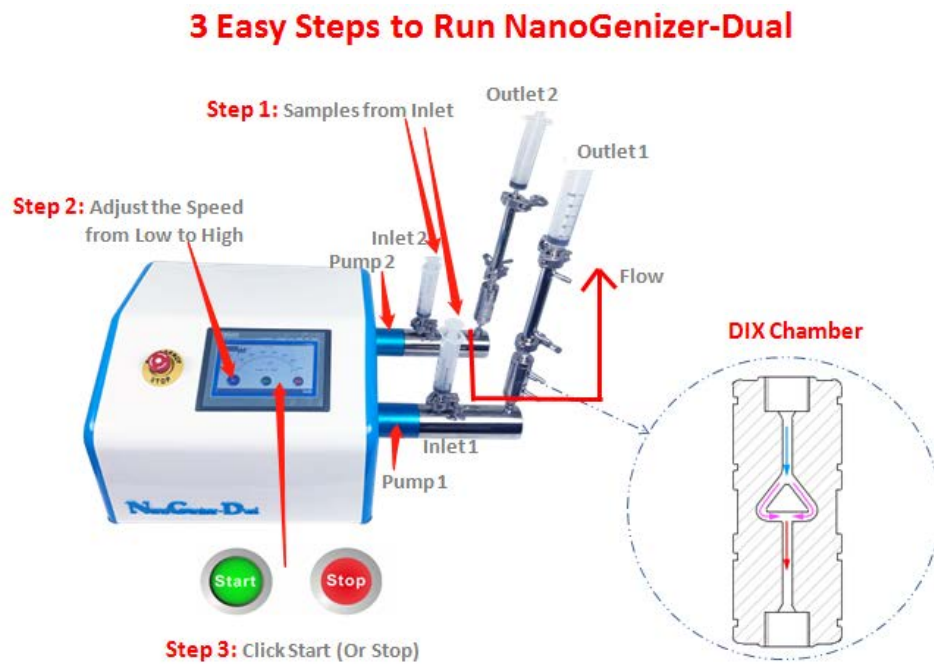

2) Two Pumps Used in Parallel:

The pump 1 pushes the sample from inlet to outlet first and then the pump 2. (The same outlet; The inlet can be the same or different)

3 Easy Steps to Run NanoGenizer-Dual

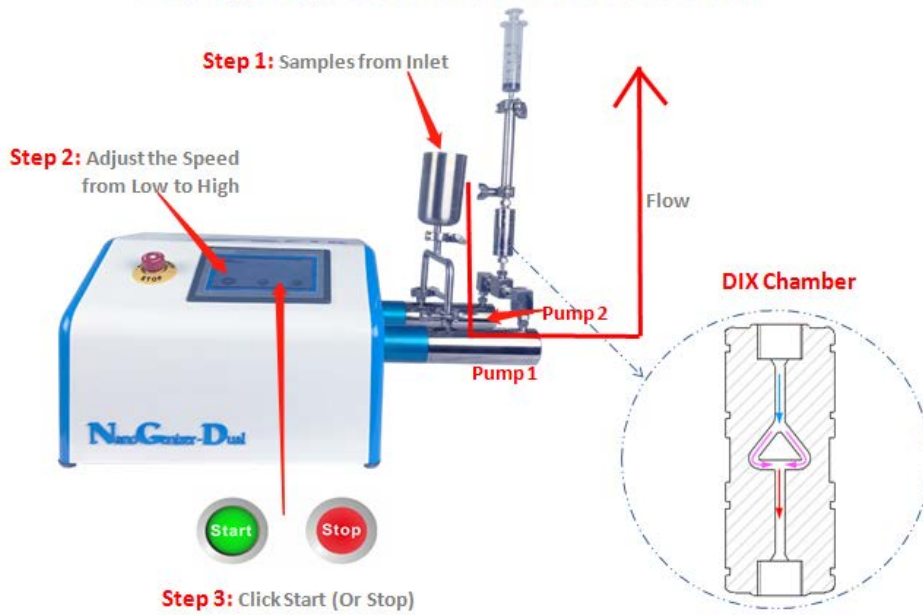

3) Two Pumps Used in Series:

The pump 1 pushes the sample from inlet to outlet 1 first and then the pump 2 pushes the sample from outlet 1 to outlet 2.

3 Easy Steps to Run NanoGenizer-Dual

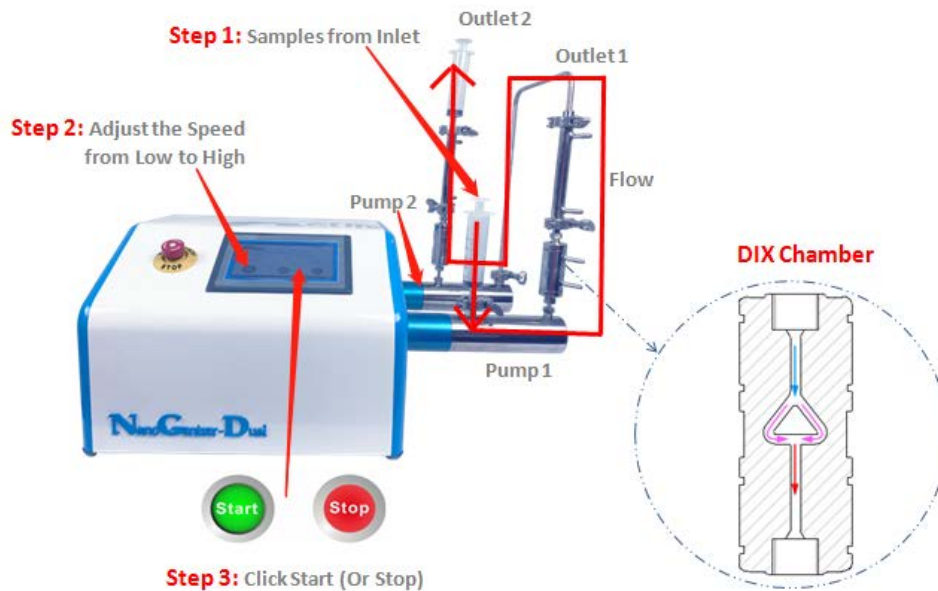

Note: Picture shown is subject to change depending on options selected by different customers.

6.2 Operation Instruction

1) Initialization Stage of the System

First, connect to the electrical outlet; when the red power light is on, switch on the power at the back of the NanoGenizer-Dual homogenizer. Once the touch screen of the homogenizer is started, all the indicator lights at the top right corner of the touch screen will be lit on, and the touch screen will show the initialization picture as following:



2)The display of the touch screen has three indicator lights on its top right corner. From left to right the three indicator lights are: RUN, the PLC indicator light; COM, the communication light; PWR, the power indicator light of the touch screen. Then machine is ready when all the lights are lit on. Otherwise, inspection is needed and the equipment cannot be started until the malfunction is resolved.

6.3 User Operation Interface

1) A loading progress bar will be shown when initialization. After loading, the touch screen will enter the user operation interface as following:

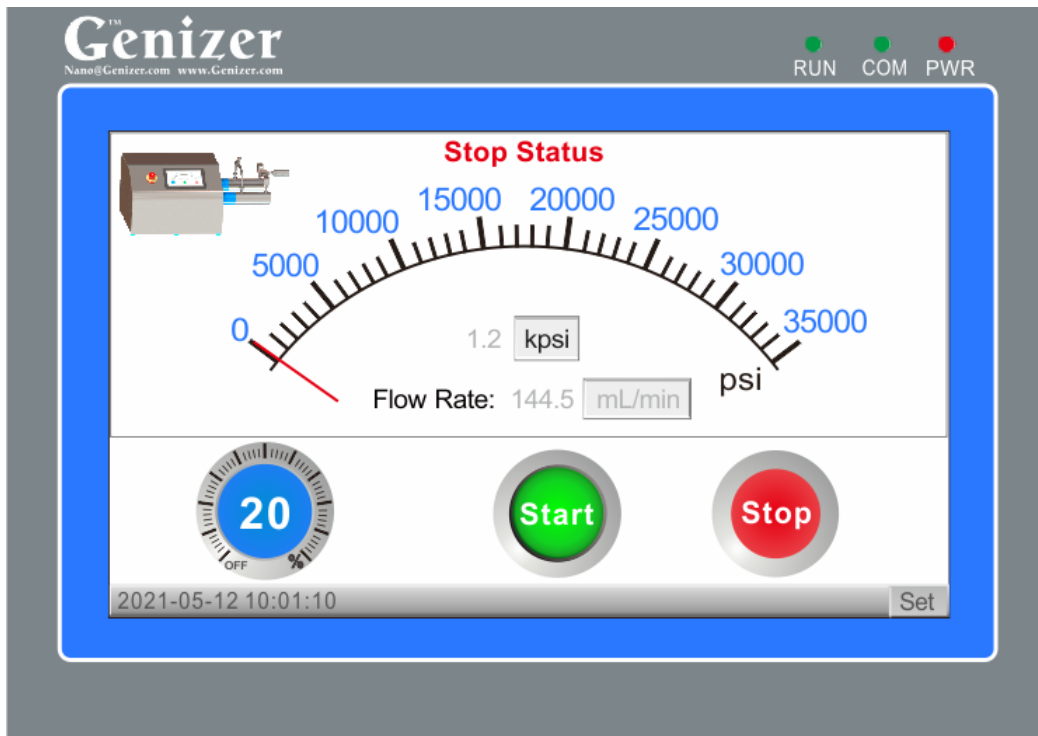

2) Animation Simulation: real time response of dual-pump operation

3) Digital pressure gauge: it indicates the pressure of the testing material.

4) Pressure value: it indicates the pressure value. And the pressure unit can be converted mutually among kPsi, MPa and Bar when the pressure unit option is clicked.

5) Flow rate: it indicates the flow rate of the homogenizer and the unit of the flow rate can be converted mutually among mL/min, L/hr and Gal/hr.

6) Power rate: it can be adjusted to reach the pressure value as needed according to the requirement of the user.

7) Start button: when it is clicked, the homogenizer will start running.

8) Stop button: when it is clicked, the homogenizer will stop running. If any special situations, please press the emergency stop button for the emergency stop.

9) The parameter setting is mainly divided to the customer setup and the factory setup.



6.4 Selection Interface for the Customer Setup & Factory Setup

When clicking "SET" in the user operation interface, the selection interface of the customer setup and the factory setup will be shown.

(Attention: Correct password is needed before entering the factory setup interface)

The parameter-setting interface has these options: Customer Setup, Factory Setup, Pressure-Time Record, User Guide and Back option.

- 1) Click "Customer Setup" and then enter the interface of the customer setup.
- 2) Click "Factory Setup", input the correct password and then enter the interface of the factory setup.
- 3) Click "Pressure-Time Record" for checking and reviewing the records of the recent-20 strokes.
- 4) Click "User Guide" for the application introduction of NanoGenizer-Dual homogenizer.
- 5) Click "Back" option and then return to the previous menu.

6.5 Customer Setup

In this interface, the user can set the running time (default as 1800 seconds); running passes; safe pressure (once exceeding, the equipment will stop immediately); the manual forward and backward option for the piston; and the back button for returning to the previous menu.

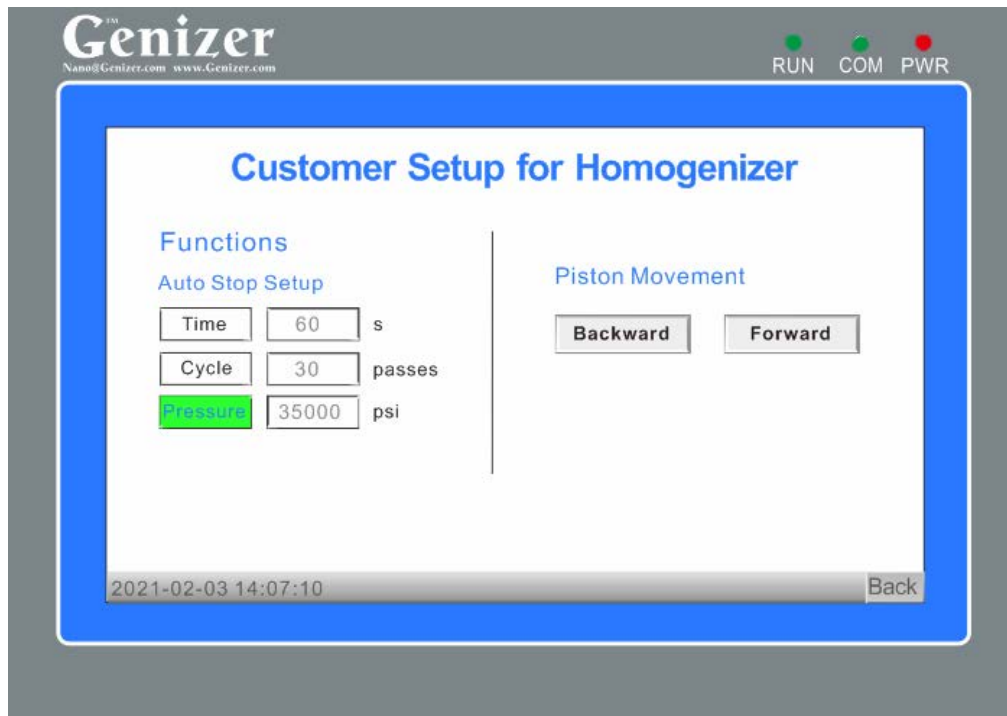

- 1) Time: set the timing and click "TIME" to start timing function, and then press the "START" button in the user operation interface to run the homogenizer. The equipment will stop automatically when the timing time is ended.
- 2) Cycle: set the cycle times and click "CYCLE" to start the circulation function. Click the "START" button to run the system. The equipment will stop when the circulation passes reach its setting value.
- 3) Pressure: set the pressure value and click "PRESSURE" to start the safe pressure function, then press the "START" button in the operation interface. The system will compare the actual running pressure with the setting safe pressure. Once the pressure is exceeded, the equipment will stop immediately.
- 4) Forward and Backward: use for the manual position calibration, maintenance or debugging.

6.6 Factory Setup

Contact the manufacturer for the information of the factory setup.

6.7 Varieties of Inlet and Outlet for NanoGenizer-Dual

Inlet: Syringe; Open Container; Stainless Steel Cylinder

Outlet: Syringe; Open Container; Stainless Steel Cylinder

When circulation operations are needed for the testing material, please using a pipe to connect the Luer outlet into the top of the inlet syringe.

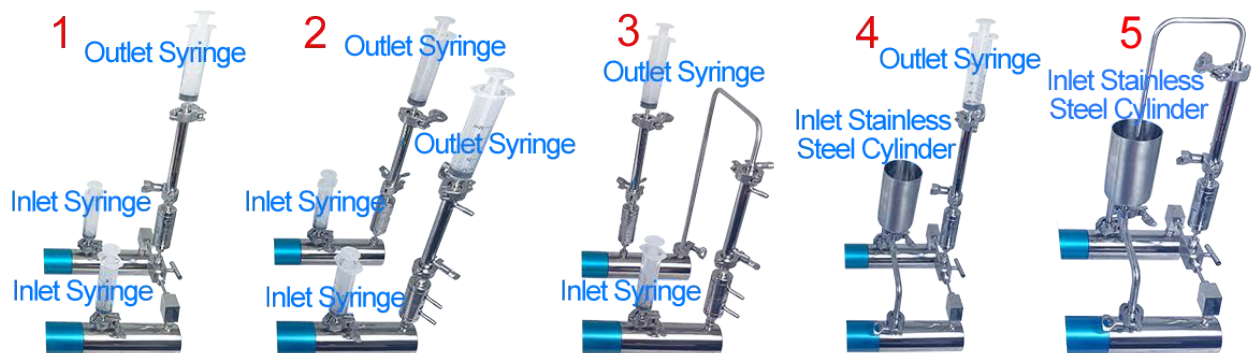

7. Trouble Shootings

7.1 Mechanical Trouble Shootings

7.1.1 Air-blocking, chamber-blocking or overload

Our design has minimized the occurrence of the air-blocking, chamber-blocking or overload. However, the improper operation of the homogenizer can still induce the malfunction or damage of the homogenizer.

1) Air Blocking

Malfunction: There is no pressure or there is no sucking from inlet.

Prevention: Do not run with empty inlet.

Reason: There is air inside the pump.

Solution: Push the Ball in the inlet valve with a pin.

2) Chamber Blocking

Malfunction: Overload of the pressure.

Prevention: Pre-treat the sample carefully; Reduce the speed.

Reason: There are aggregations or large particles in the sample; Or the equipment runs too fast.

Solution: Reverse the interaction chamber with water at low speed.

3) Overload

Solution: Reduce the speed and shut down the power, wait for **30 sec** and restart again; or flush with water or suitable solvent; or run with clean and homo-disperse sample.

7.1.2 When the pressure is down:

1) Circuit malfunction: check whether all the indicator lights are working well.

2) Malfunction in high pressure pump body: check whether the high pressure pump body is working well.

3) Malfunction in the inlet port: check whether the one-way check valve is working well.

4) Leaking of the hydraulic system: check whether every joint is connected correctly.

7.1.3 When the high pressure pump sending out abnormal noise:

If the high pressure pump has foreign matters or serious abrasion, it should be returned to the factory for repair.

7.2 Trouble Shootings of Electric Appliance

7.2.1 The red switch of the power supply does not light on

- 1) If the fuse is blowout, please replace the fuse.
- 2) If the equipment is not connected with power supply, please connect it with the power supply.
- 3) If the outlet is not plugged well, please plug it again.

7.2.2 If the RUN light, COM light and the POWER light of the touch screen do not light on.

- 1) Please check whether touch screen is connected with power supply or not.
- 2) If the touch screen is black out, please contact the customer service.

7.2.3 If the equipment does not work when pressing the green "START" button, please turn off the power supply and restart it after **30 seconds**.



The control system needs a few seconds for rebuilding. If the problem remains, please contact the customer service.

8. Maintenance

8.1 Cleaning

Please clean the equipment before turning off the system. Please use the solvent, alcohol or water in turn for flushing. Do not let the material stay for a long time, especially the viscous or indurate material.



Attention: Service or maintenance work is prohibited when the system is running.



Attention: Ensure that the pressure of the system has been released and the power supply has been turned off safely before implementing the service or maintenance work.

8.2 High Pressure Weep Holes

Some of the high pressure components have weep holes. Please check regularly whether the system is leaking or not, please turn off the equipment once leaking. Because the system is operating under the high pressure, even the little leakage would damage the sealing element in a few minutes.

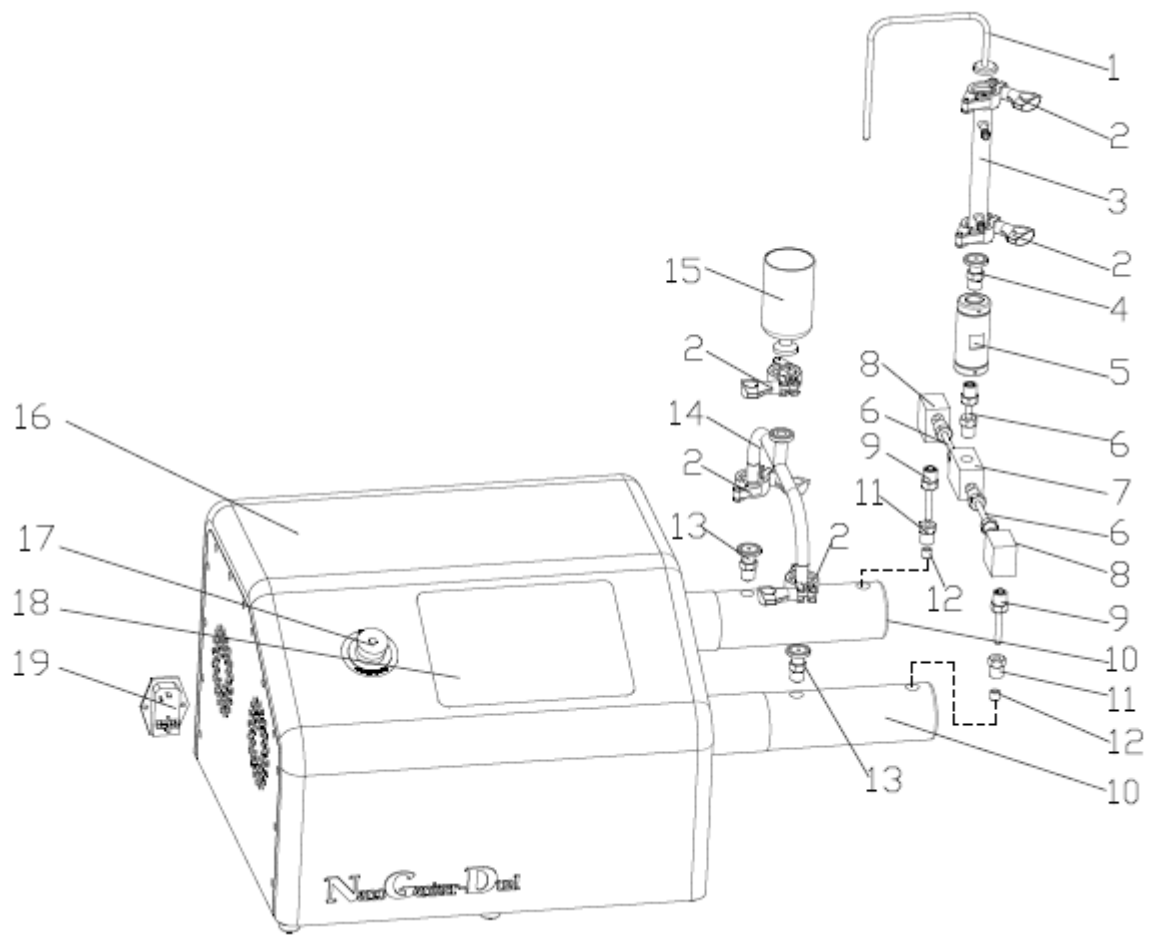

General Arrangement Drawing of NanoGenizer-Dual Used in Parallel

Components List

Components List			
Item	Component model	Quantity	Component name
1	NGD-OP	1	Outlet S/S Pipe
2	NGD-TRI-CLMP	5	Tri-Clamp
3	NGD-HPE150	1	High Pressure Exchanger
4	NGD-FRRL	1	Ferrule
5	NGD-DIXC	1	Diamond Interaction Chamber (DIXC)
6	NGD-HF4HPC	3	HF4 High Pressure Connection
7	NGD-T	1	Tee
8	NGD-ELW	2	Elbow
9	NGD-FV-OUT	2	Outlet Filter Valve
10	NGD-HPC	2	High Pressure Cylinder
11	NGD-SP-GLD	2	High Pressure Gland
12	NGD-SP-CLLR	2	High Pressure Collar
13	NGD-CV-IN	2	Inlet Check Valve
14	NGD-IC	1	Inlet Connection
15	NGD-FR	1	Feed Reservoir
16	NGD-OS	1	Outer Shell
17	NGD-ES	1	Emergency Stop
18	NGD-PLC-TS	1	PLC Touch Screen
19	NGD-PSP	1	Power Supply

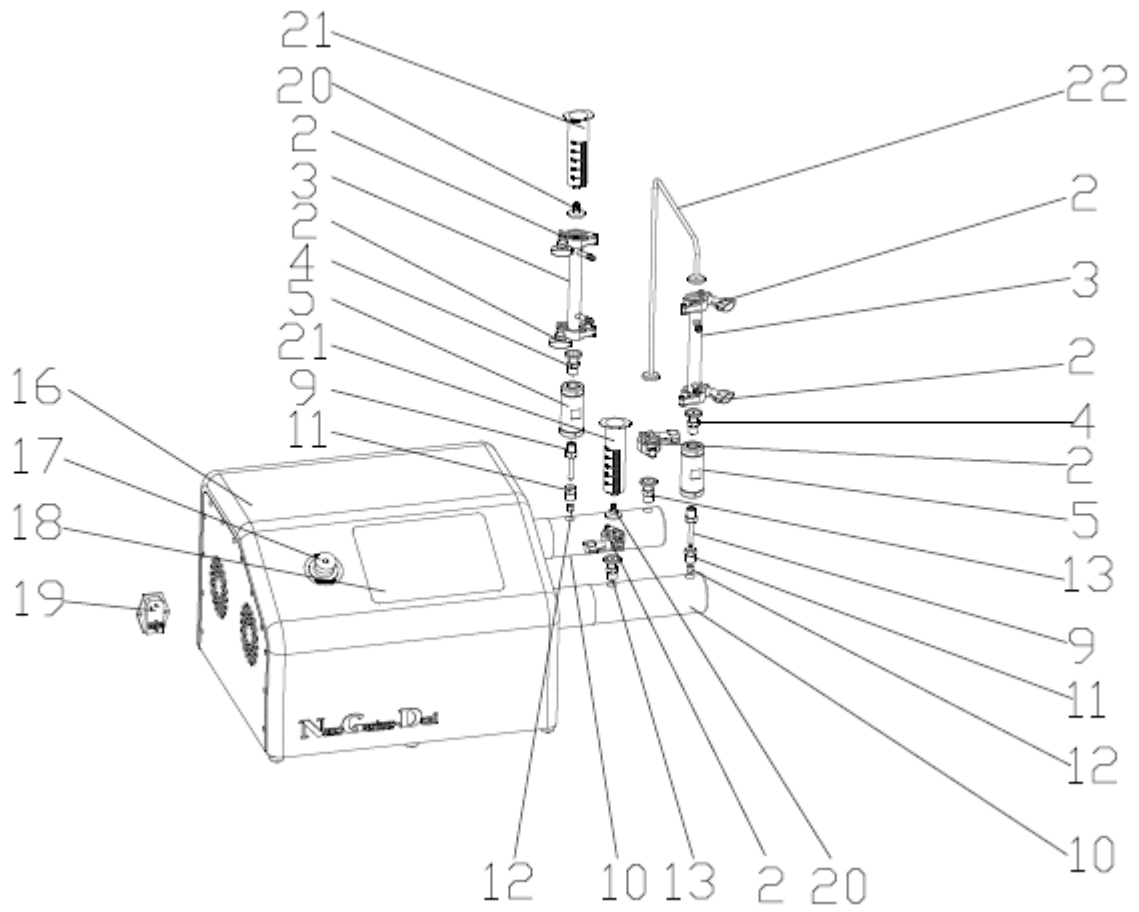

General Arrangement Drawing of NanoGenizer-Dual Used in Series

Components List

Components List			
Item	Component model	Quantity	Component name
2	NGD-TRI-CLMP	6	Tri-Clamp
3	NGD-HPE150	2	High Pressure Exchanger
4	NGD-FRRL	2	Ferrule
5	NGD-DIXC	2	Diamond Interaction Chamber (DIXC)
9	NGD-FV-OUT	2	Outlet Filter Valve
10	NGD-HPC	2	High Pressure Cylinder
11	NGD-SP-GLD	2	High Pressure Gland
12	NGD-SP-CLLR	2	High Pressure Collar
13	NGD-CV-IN	2	Inlet Check Valve
16	NGD-OS	1	Outer Shell
17	NGD-ES	1	Emergency Stop
18	NGD-PLC-TS	1	PLC Touch Screen
19	NGD-PSP	1	Power Supply
20	NGD-LO	2	Luer Outlet
21	NGD-PS	2	Plastic Syringe
22	NGD-ETTC	1	Elbow tubing with Tri-Clamp

Extra parts: One set of disassemble & assemble tool unit for seal parts, two pieces of wrenches, two pieces of extra plunger seal, two pieces of extra fuse, two pieces of extra luer outlet hoses.

Remarks: the plastic syringes can be replaced by other containers (S/S Cylinder or glass container).

Note: 1. The specification, structure and parameter may be modified without notification.

2. The Dimensions, structure and parameter should be subject to the final product.